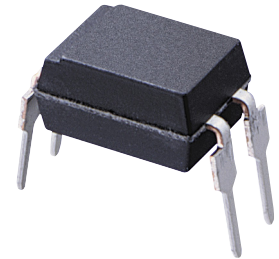


# PC815XJ0000F Series

\*4-channel package type is also available.  
(model No. **PC845XJ0000F Series**)

DIP 4pin  
Darlington Phototransistor Output,  
Photocoupler



## ■ Description

**PC815XJ0000F Series** contains an IRED optically coupled to a phototransistor.

It is packaged in a 4 pin DIP.

Input-output isolation voltage(rms) is 5.0 kV.

CTR is MIN. 600% at input current of 1.0 mA.

## ■ Features

1. 4 pin DIP package
2. Double transfer mold package  
(Ideal for Flow Soldering)
3. Darlington phototransistor output (CTR : MIN. 600%  
at  $I_F=1.0$  mA,  $V_{CE}=2$  V)
4. High isolation voltage between input and output  
( $V_{iso(rms)}$  : 5.0 kV)
5. Lead-free and RoHS directive compliant

## ■ Agency approvals/Compliance

1. Recognized by UL1577 (Double protection isolation),  
file No. E64380 (as model No. **PC815**)
2. Approved by VDE, DIN EN60747-5-2<sup>(\*)</sup> (as an  
option), file No. 40008087 (as model No. **PC815**)
3. Package resin : UL flammability grade (94V-0)

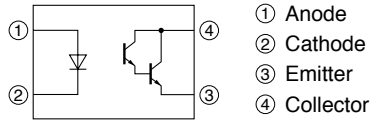
<sup>(\*)</sup> DIN EN60747-5-2 : successor standard of DIN VDE0884.

## ■ Applications

1. Home appliances
2. Programmable controller
3. Signal transmission between circuits of different  
potentials and impedances

Notice The content of data sheet is subject to change without prior notice.  
In the absence of confirmation by device specification sheets, SHARP takes no responsibility for any defects that may occur in equipment using any SHARP devices shown in catalogs, data books, etc. Contact SHARP in order to obtain the latest device specification sheets before using any SHARP device.

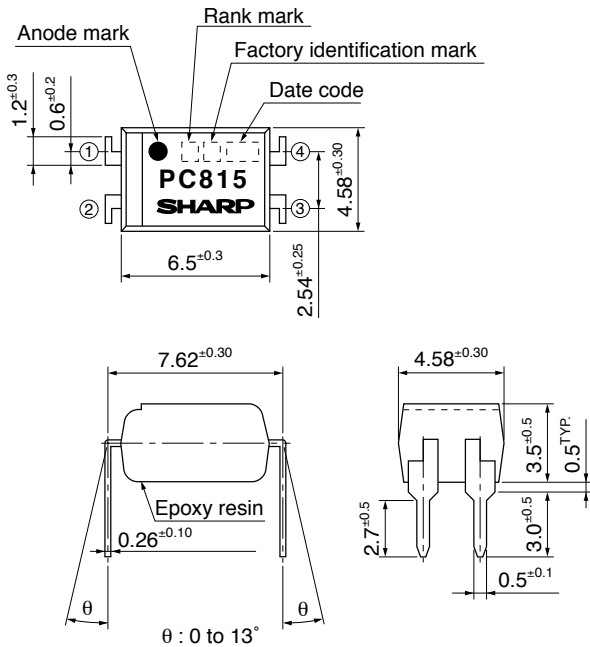
## Internal Connection Diagram



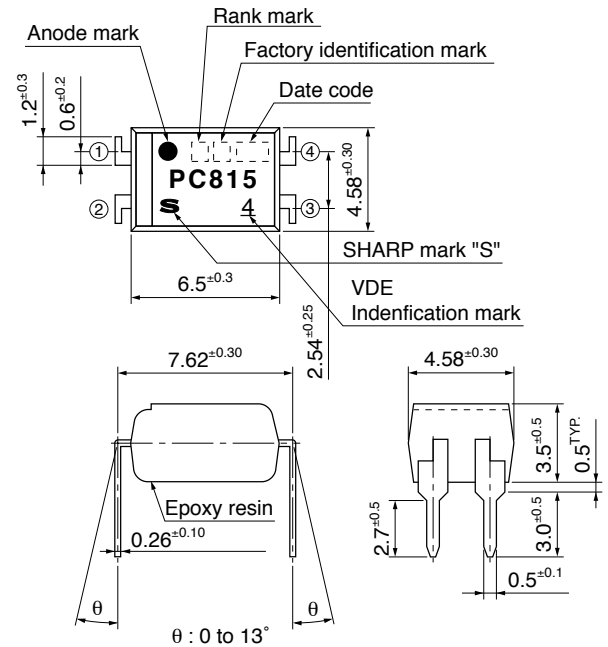
## Outline Dimensions

(Unit : mm)

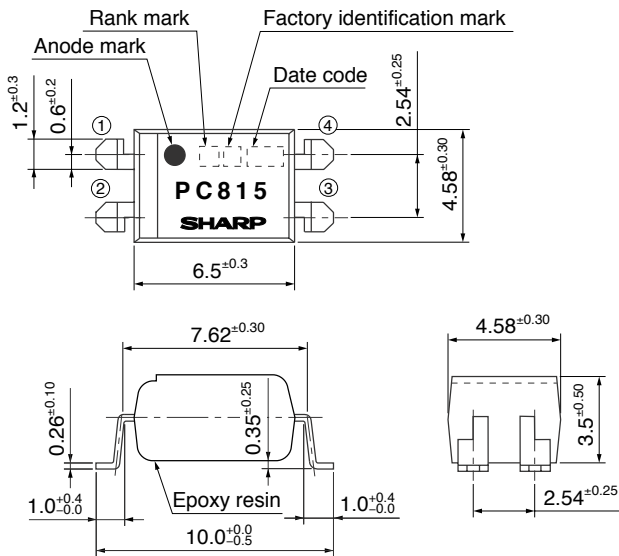
### 1. Through-Hole [ex. PC815XJ0000F]



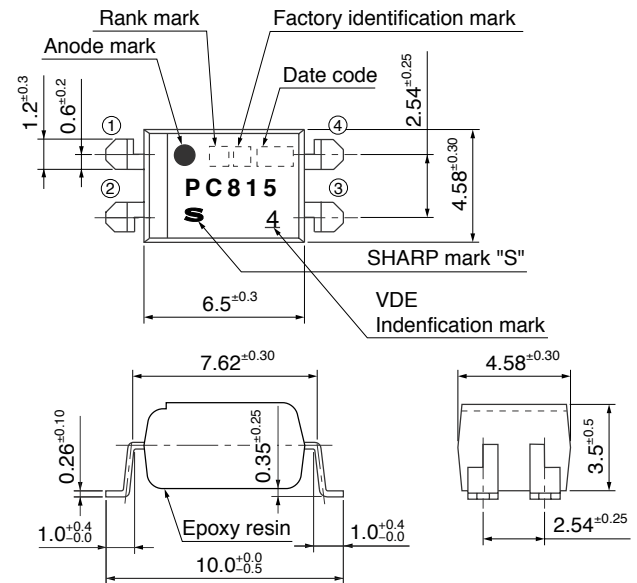
### 2. Through-Hole (VDE option) [ex. PC815XYJ0000F]



### 3. SMT Gullwing Lead-Form [ex. PC815XPJ0000F]



### 4. SMT Gullwing Lead-Form (VDE option) [ex. PC815XPYJ0000F]






Plating material : SnCu (Cu : TYP. 2%)

## Date code (2 digit)

1st digit				2nd digit	
Year of production				Month of production	
A.D.	Mark	A.D.	Mark	Month	Mark
1990	A	2002	P	January	1
1991	B	2003	R	February	2
1992	C	2004	S	March	3
1993	D	2005	T	April	4
1994	E	2006	U	May	5
1995	F	2007	V	June	6
1996	H	2008	W	July	7
1997	J	2009	X	August	8
1998	K	2010	A	September	9
1999	L	2011	B	October	O
2000	M	2012	C	November	N
2001	N	:	:	December	D

repeats in a 20 year cycle

## Factory identification mark

Factory identification Mark	Country of origin
no mark	Japan
	
	Indonesia
	China

\* This factory marking is for identification purpose only.  
Please contact the local SHARP sales representative to see the actual status of the production.

## Rank mark

With or without.

### ■ Absolute Maximum Ratings (T<sub>a</sub>=25°C)

Parameter		Symbol	Rating	Unit
Input	Forward current	I <sub>F</sub>	50	mA
	*1 Peak forward current	I <sub>FM</sub>	1	A
	Reverse voltage	V <sub>R</sub>	6	V
	Power dissipation	P	70	mW
Output	Collector-emitter voltage	V <sub>CEO</sub>	35	V
	Emitter-collector voltage	V <sub>ECO</sub>	6	V
	Collector current	I <sub>C</sub>	80	mA
	Collector power dissipation	P <sub>C</sub>	150	mW
Total power dissipation		P <sub>tot</sub>	200	mW
Operating temperature		T <sub>opr</sub>	-30 to +100	°C
Storage temperature		T <sub>stg</sub>	-55 to +125	°C
*2 Isolation voltage		V <sub>iso(rms)</sub>	5	kV
*3 Soldering temperature		T <sub>sol</sub>	270	°C

\*1 Pulse width ≤ 100ms, Duty ratio : 0.001

\*2 40 to 60%RH, AC for 1minute, f=60Hz

\*3 For 10s

### ■ Electro-optical Characteristics (T<sub>a</sub>=25°C)

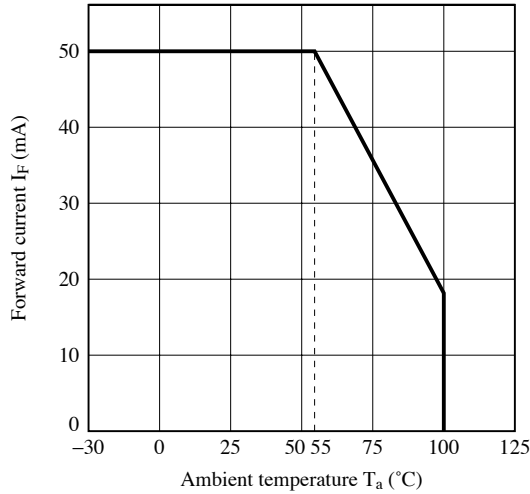
Parameter		Symbol	Condition	MIN.	TYP.	MAX.	Unit
Input	Forward voltage	V <sub>F</sub>	I <sub>F</sub> =20mA	-	1.2	1.4	V
	Peak forward voltage	V <sub>FM</sub>	I <sub>FM</sub> =0.5V	-	-	3.0	V
	Reverse current	I <sub>R</sub>	V <sub>R</sub> =4V	-	-	10	μA
	Terminal capacitance	C <sub>t</sub>	V=0, f=1kHz	-	30	250	pF
Output	Collector dark current	I <sub>CEO</sub>	V <sub>CE</sub> =10V, I <sub>F</sub> =0	-	-	1 000	nA
	Collector-emitter breakdown voltage	BV <sub>CEO</sub>	I <sub>C</sub> =0.1mA, I <sub>F</sub> =0	35	-	-	V
	Emitter-collector breakdown voltage	BV <sub>ECO</sub>	I <sub>E</sub> =10μA, I <sub>F</sub> =0	6	-	-	V
Transfer characteristics	Current transfer ratio	I <sub>C</sub>	I <sub>F</sub> =1mA, V <sub>CE</sub> =2V	6.0	16.0	75.0	mA
	Collector-emitter saturation voltage	V <sub>CE(sat)</sub>	I <sub>F</sub> =20mA, I <sub>C</sub> =5mA	-	0.8	1.0	V
	Isolation resistance	R <sub>ISO</sub>	DC500V, 40 to 60%RH	5×10 <sup>10</sup>	1×10 <sup>11</sup>	-	Ω
	Floating capacitance	C <sub>f</sub>	V=0, f=1MHz	-	0.6	1.0	pF
	Cut-off frequency	f <sub>C</sub>	V <sub>CE</sub> =2V, I <sub>C</sub> =2mA, R <sub>L</sub> =100Ω, -3dB	1	6	-	kHz
	Response time	Rise time	t <sub>r</sub>	V <sub>CE</sub> =2V, I <sub>C</sub> =10mA, R <sub>L</sub> =100Ω	-	60	300
Fall time		t <sub>f</sub>	-		53	250	μs

**■ Model Line-up**

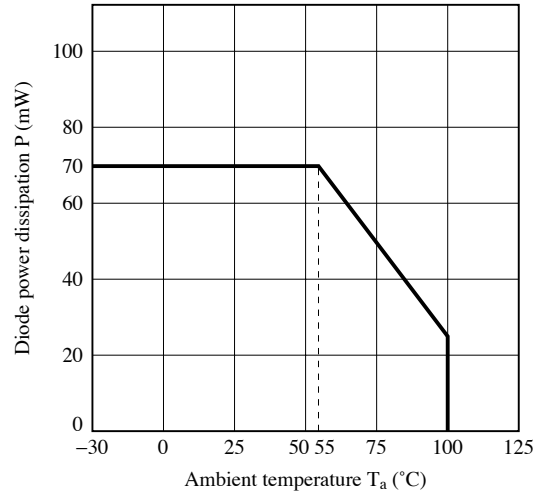
Lead Form	Through-Hole		SMT Gullwing Form	
Package	Sleeve		Taping	
	100pcs/sleeve		2 000pcs/reel	
DIN EN60747-5-2	—	Approved	—	Approved
Model No.	<b>PC815XJ0000F</b>	<b>PC815XYJ000F</b>	<b>PC815XPJ000F</b>	<b>PC815XPYJ00F</b>

Please contact a local SHARP sales representative to inquire about production status.

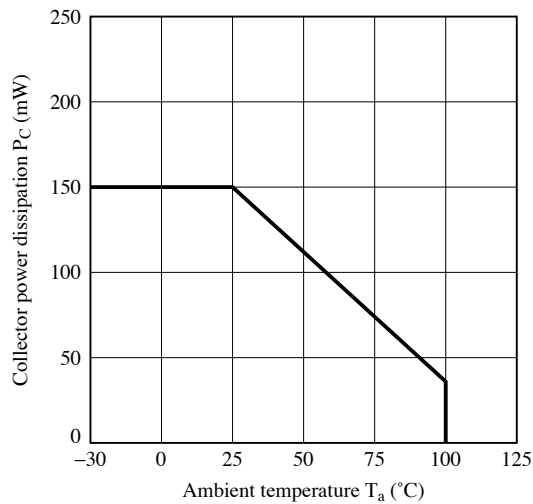
**Fig.1 Forward Current vs. Ambient Temperature**



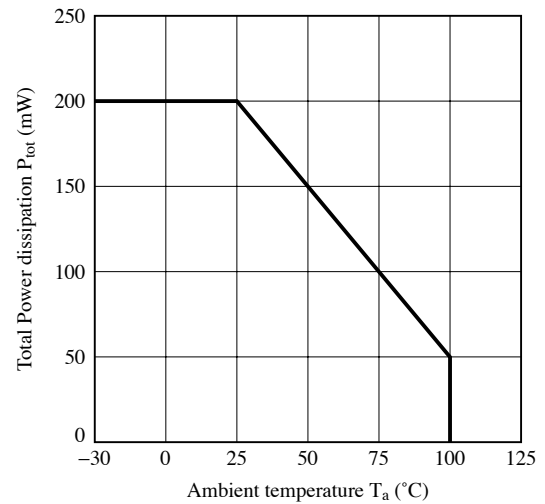
**Fig.2 Diode Power Dissipation vs. Ambient Temperature**



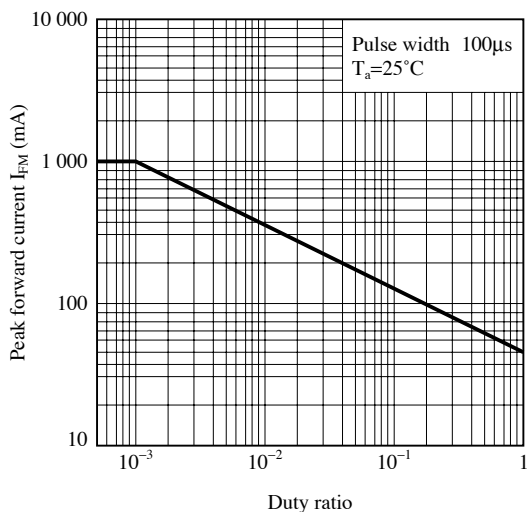
**Fig.3 Collector Power Dissipation vs. Ambient Temperature**



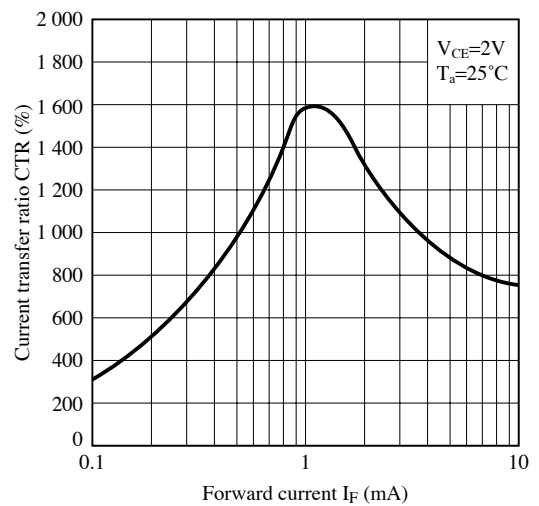
**Fig.4 Total Power Dissipation vs. Ambient Temperature**



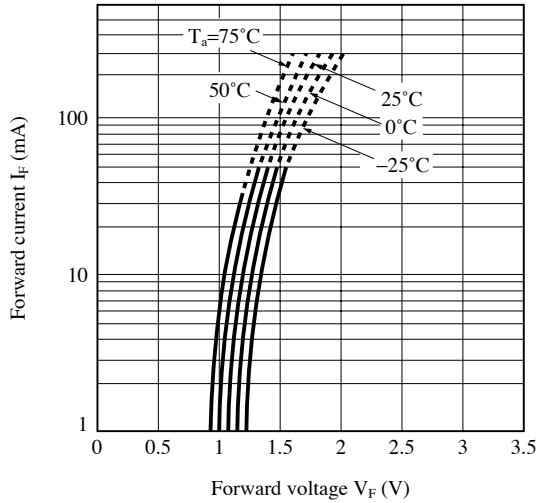
**Fig.5 Peak Forward Current vs. Duty Ratio**



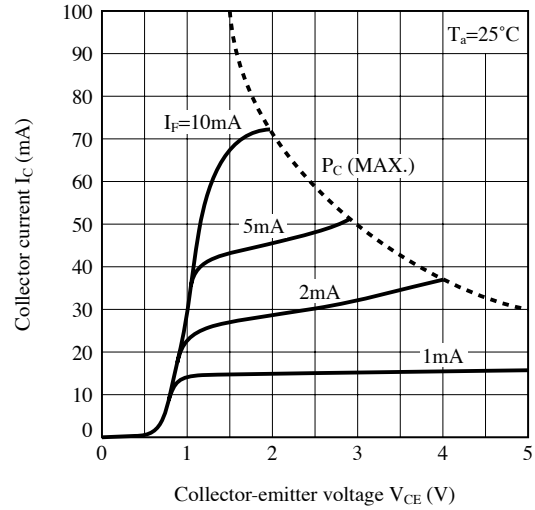
**Fig.6 Current Transfer Ratio vs. Forward Current**



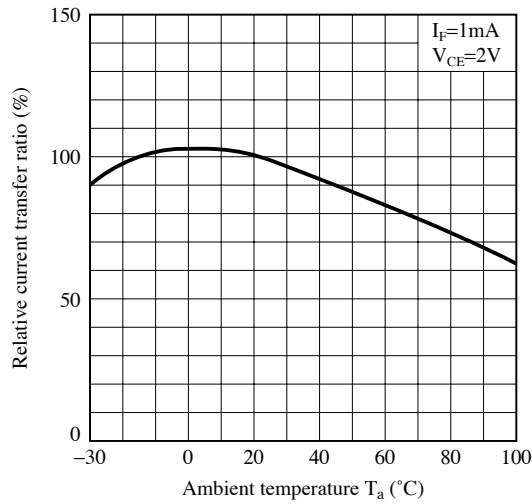
**Fig.7 Forward Current vs. Forward Voltage**



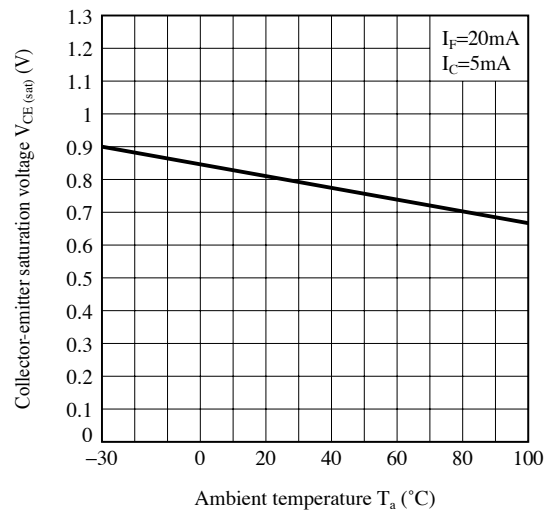
**Fig.8 Collector Current vs. Collector-emitter Voltage**



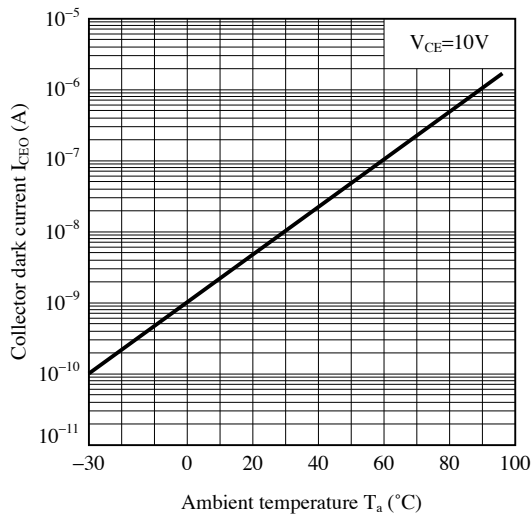
**Fig.9 Relative Current Transfer Ratio vs. Ambient Temperature**



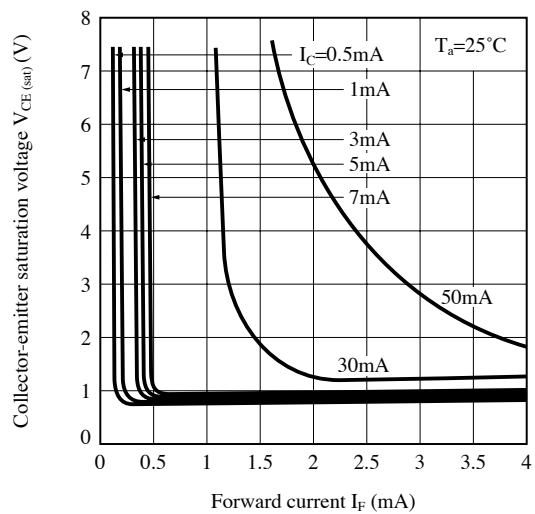
**Fig.10 Collector - emitter Saturation Voltage vs. Ambient Temperature**



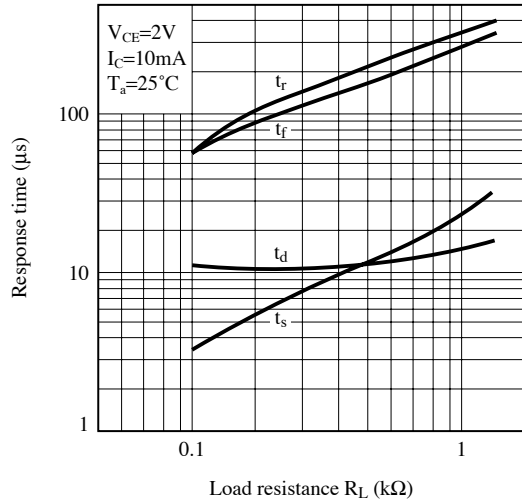
**Fig.11 Collector Dark Current vs. Ambient Temperature**



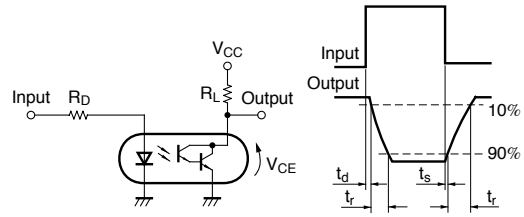
**Fig.12 Collector-emitter Saturation Voltage vs. Forward Current**



**Fig.11 Response Time vs. Load Resistance**

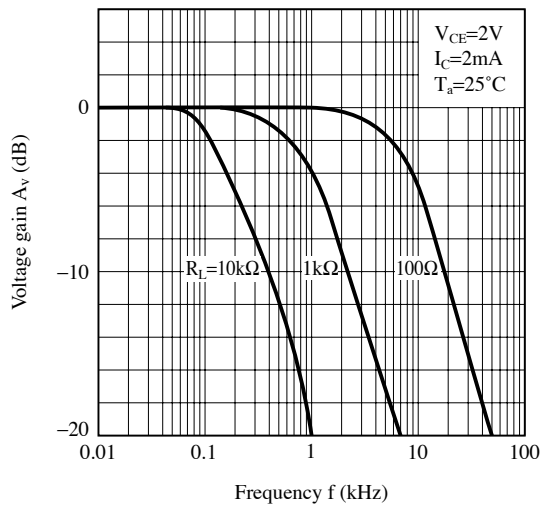


**Fig.12 Test Circuit for Response Time**

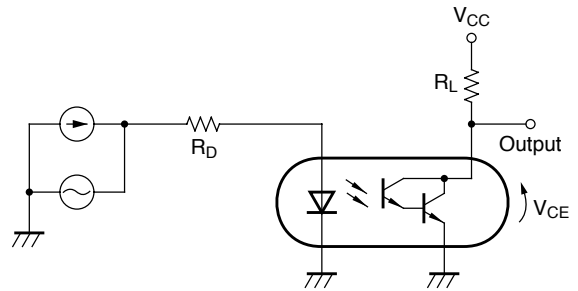


Please refer to the conditions in Fig.13

**Fig.13 Frequency Response**



**Fig.14 Test Circuit for Frequency Response**



Please refer to the conditions in Fig.15

Remarks : Please be aware that all data in the graph are just for reference and not for guarantee.



■ **Design Considerations**

● **Design guide**

While operating at  $I_F < 1.0\text{mA}$ , CTR variation may increase.  
Please make design considering this fact.

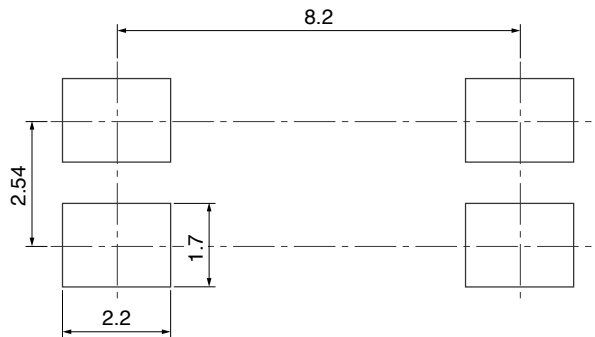
This product is not designed against irradiation and incorporates non-coherent IRED.

● **Degradation**

In general, the emission of the IRED used in photocouplers will degrade over time.  
In the case of long term operation, please take the general IRED degradation (50% degradation over 5 years) into the design consideration.

● **Recommended foot print (reference)**

SMT Gullwing Lead-form



(Unit : mm)

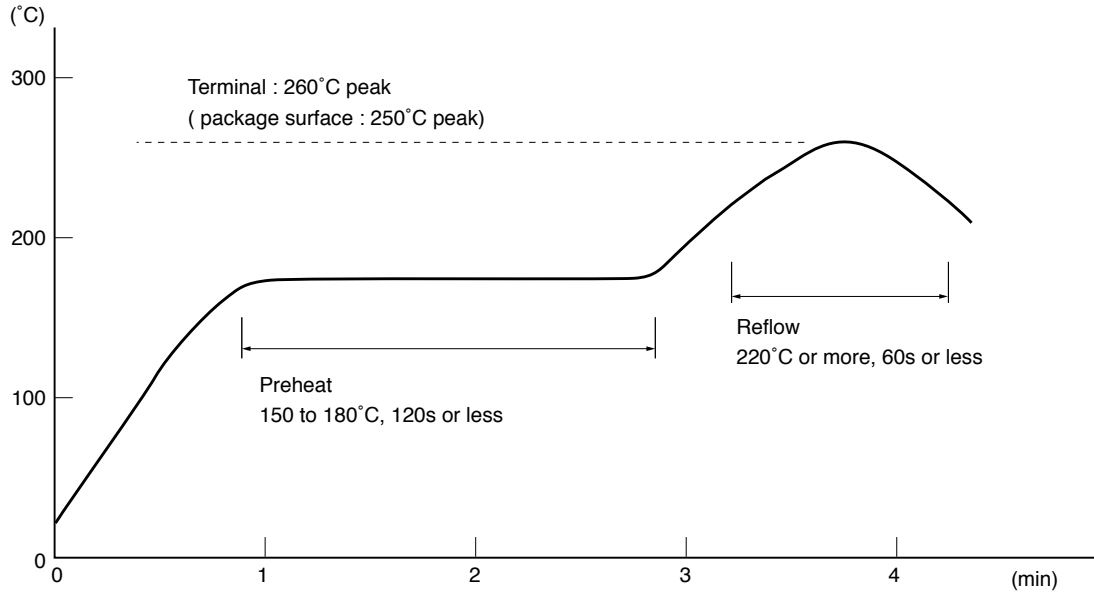
☆ For additional design assistance, please review our corresponding Optoelectronic Application Notes.

■ **Manufacturing Guidelines**

● **Soldering Method**

Reflow Soldering:

Reflow soldering should follow the temperature profile shown below.  
 Soldering should not exceed the curve of temperature profile and time.  
 Please don't solder more than twice.



Flow Soldering :

Due to SHARP's double transfer mold construction submersion in flow solder bath is allowed under the below listed guidelines.

Flow soldering should be completed below 270 °C and within 10s.  
 Preheating is within the bounds of 100 to 150 °C and 30 to 80s.  
 Please don't solder more than twice.

Hand soldering

Hand soldering should be completed within 3s when the point of solder iron is below 400 °C.  
 Please don't solder more than twice.

Other notice

Please test the soldering method in actual condition and make sure the soldering works fine, since the impact on the junction between the device and PCB varies depending on the tooling and soldering conditions.

**● Cleaning instructions****Solvent cleaning :**

Solvent temperature should be 45°C or below. Immersion time should be 3 minutes or less.

**Ultrasonic cleaning :**

The impact on the device varies depending on the size of the cleaning bath, ultrasonic output, cleaning time, size of PCB and mounting method of the device.

Therefore, please make sure the device withstands the ultrasonic cleaning in actual conditions in advance of mass production.

**Recommended solvent materials :**

Ethyl alcohol, Methyl alcohol and Isopropyl alcohol.

In case the other type of solvent materials are intended to be used, please make sure they work fine in actual using conditions since some materials may erode the packaging resin.

**● Presence of ODC**

This product shall not contain the following materials.

And they are not used in the production process for this product.

Regulation substances : CFCs, Halon, Carbon tetrachloride, 1.1.1-Trichloroethane (Methylchloroform)

Specific brominated flame retardants such as the PBB and PBDE are not used in this product at all.

This product shall not contain the following materials banned in the RoHS Directive (2002/95/EC).

•Lead, Mercury, Cadmium, Hexavalent chromium, Polybrominated biphenyls (PBB), Polybrominated diphenyl ethers (PBDE).

**■ Package specification****● Sleeve package**

## Package materials

Sleeve : HIPS (with anti-static material)

Stopper : Styrene-Elastomer

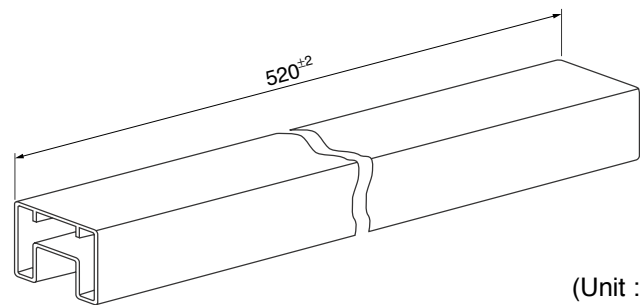
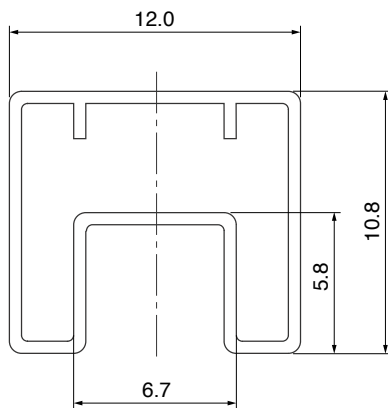
## Package method

MAX. 100 pcs. of products shall be packaged in a sleeve. Both ends shall be closed by tabbed and tabless stoppers.

The product shall be arranged in the sleeve with its anode mark on the tabless stopper side.

MAX. 20 sleeves in one case.

## Sleeve outline dimensions



(Unit : mm)

## ● Tape and Reel package

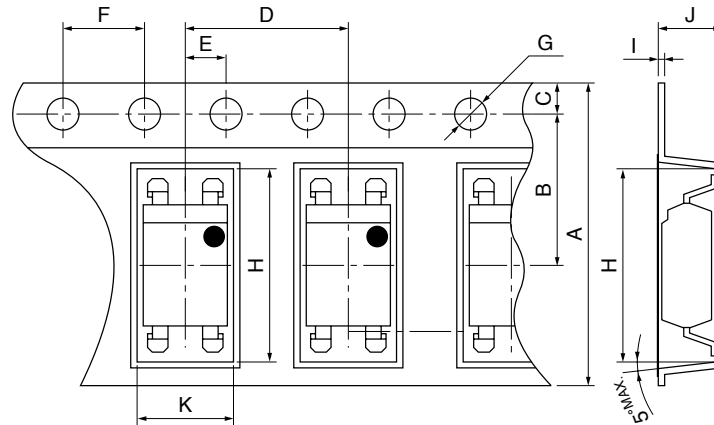
### Package materials

Carrier tape : PS

Cover tape : PET (three layer system)

Reel : PS

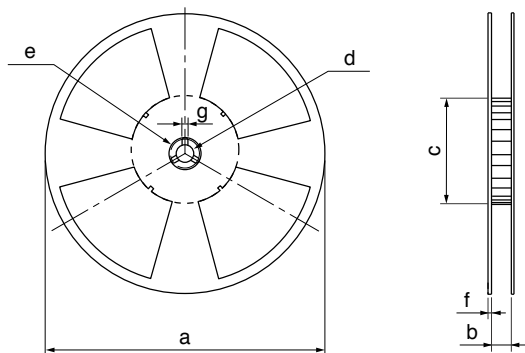
### Carrier tape structure and Dimensions



Dimensions List (Unit : mm)

A	B	C	D	E	F	G
16.0±0.3	7.5±0.1	1.75±0.10	8.0±0.1	2.0±0.1	4.0±0.1	φ1.5±0.1 0.0
H	I	J	K			
10.4±0.1	0.40±0.05	4.2±0.1	5.1±0.1			

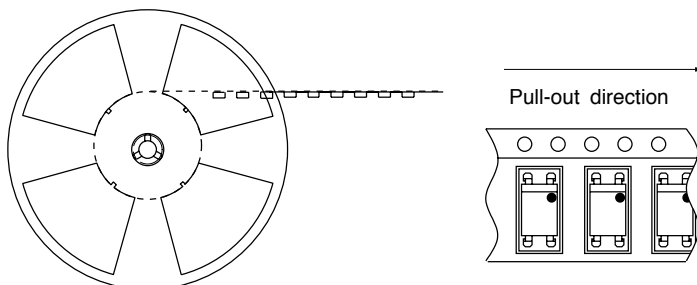
### Reel structure and Dimensions



Dimensions List (Unit : mm)

a	b	c	d
φ330	17.5±1.5	φ100.0±1.0	φ13.0±0.5
e	f	g	
φ23.0±1.0	2.0±0.5	2.0±0.5	

### Direction of product insertion



[Packing : 2 000pcs/reel]

**■ Important Notices**

· The circuit application examples in this publication are provided to explain representative applications of SHARP devices and are not intended to guarantee any circuit design or license any intellectual property rights. SHARP takes no responsibility for any problems related to any intellectual property right of a third party resulting from the use of SHARP's devices.

· Contact SHARP in order to obtain the latest device specification sheets before using any SHARP device. SHARP reserves the right to make changes in the specifications, characteristics, data, materials, structure, and other contents described herein at any time without notice in order to improve design or reliability. Manufacturing locations are also subject to change without notice.

· Observe the following points when using any devices in this publication. SHARP takes no responsibility for damage caused by improper use of the devices which does not meet the conditions and absolute maximum ratings to be used specified in the relevant specification sheet nor meet the following conditions:

(i) The devices in this publication are designed for use in general electronic equipment designs such as:

- Personal computers
- Office automation equipment
- Telecommunication equipment [terminal]
- Test and measurement equipment
- Industrial control
- Audio visual equipment
- Consumer electronics

(ii) Measures such as fail-safe function and redundant design should be taken to ensure reliability and safety when SHARP devices are used for or in connection

with equipment that requires higher reliability such as:

- Transportation control and safety equipment (i.e., aircraft, trains, automobiles, etc.)
- Traffic signals
- Gas leakage sensor breakers
- Alarm equipment
- Various safety devices, etc.

(iii) SHARP devices shall not be used for or in connection with equipment that requires an extremely high level of reliability and safety such as:

- Space applications
- Telecommunication equipment [trunk lines]
- Nuclear power control equipment
- Medical and other life support equipment (e.g., scuba).

· If the SHARP devices listed in this publication fall within the scope of strategic products described in the Foreign Exchange and Foreign Trade Law of Japan, it is necessary to obtain approval to export such SHARP devices.

· This publication is the proprietary product of SHARP and is copyrighted, with all rights reserved. Under the copyright laws, no part of this publication may be reproduced or transmitted in any form or by any means, electronic or mechanical, for any purpose, in whole or in part, without the express written permission of SHARP. Express written permission is also required before any use of this publication may be made by a third party.

· Contact and consult with a SHARP representative if there are any questions about the contents of this publication.